

 **innova**

**..2.0**  
Two holes,  
no outdoor  
units



**Design should not beautify  
but simplify.  
We did it.**



..2.0



..2.0 VERTICAL





..20 MINI





# ..2.0

**Almost invisible, powerful,  
noiseless and space-saving:  
this is the INNOVA air conditioner  
without an external unit**

No more of the usual bulky, unsightly condensing units that spoil homes. INNOVA has developed a high-efficiency solution with a hyper-compact design that minimises aesthetic impact. Just 16 centimetres deep, super simple installation and DC Inverter technology to optimise performance.

## Optimised power, reduced consumption and noise

With DC Inverter technology, the powers are optimised for maximum comfort with less consumption and noise, and thanks to Dual Power you can use maximum power to reach the required temperature in the shortest possible time. Once reached, the ..2.0 automatically adjusts itself in function of comfort.

The external grilles are foldable: they open when the machine is running and close when it is switched off, so as to minimise dust, noise and pollution, maximising comfort.

The ..2.0 MINI version is really eco-friendly because it uses R290 propane gas. Zero emission.

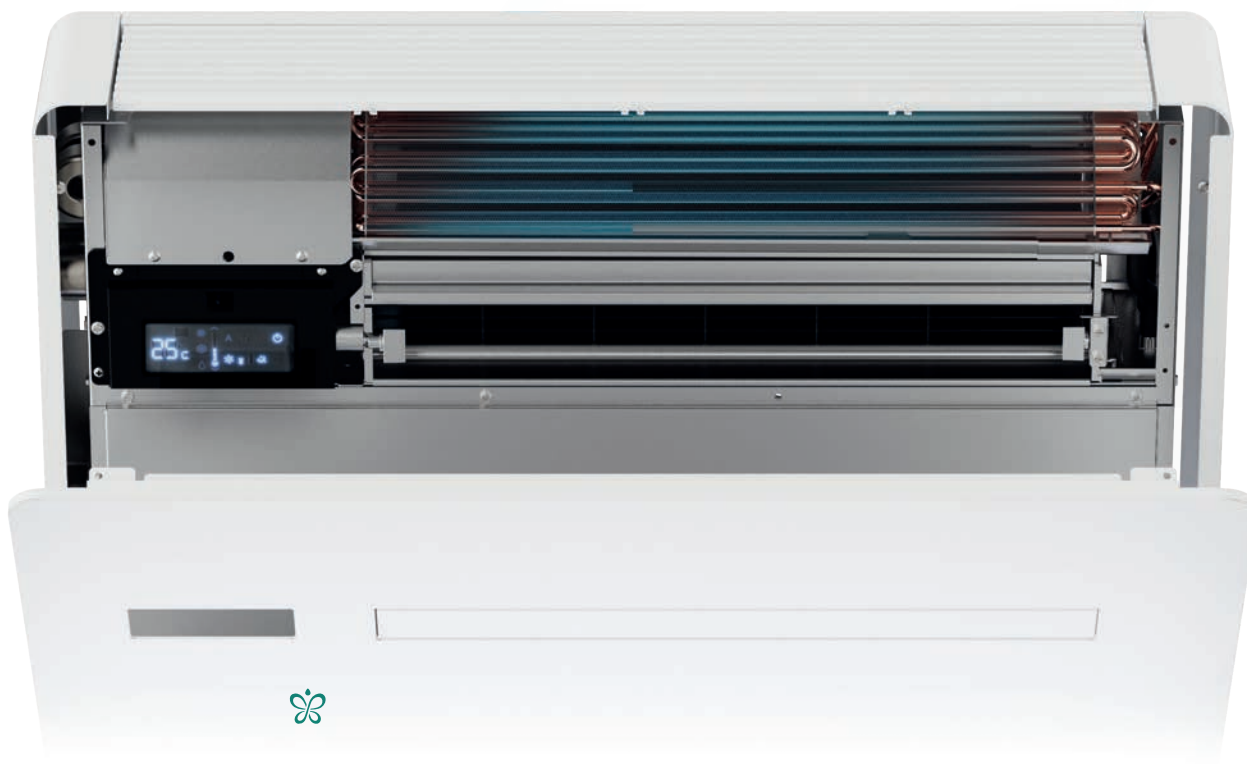
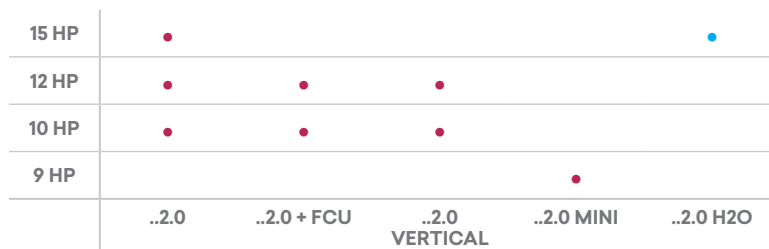





..20 + FCU

## High on the wall or down on the floor?

..2.0 from INNOVA can count on a complete product range that allows you to find the right model for every type of installation. All you need is an external wall and you can find the space to insert it high up on the wall, low down on the floor, in the corner or to the side of a French door. Maximum versatility to meet every need.

### Down installation

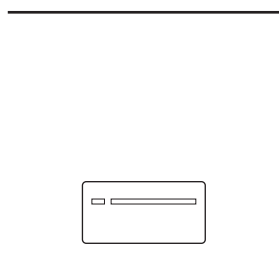

### Overhead installation

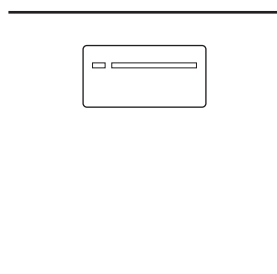

### Installation on the side

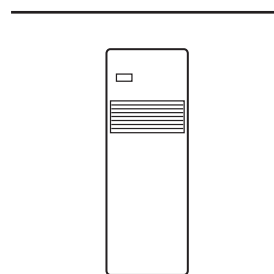

### Control modes



Integrated touch-screen



Remote touch-screen

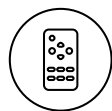

Handset control



iOS and Android APP

### Perimetral installation

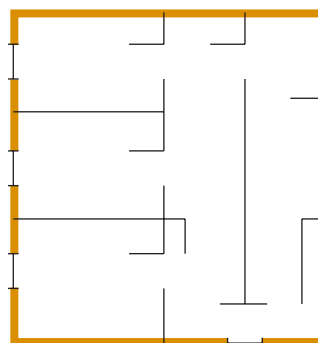

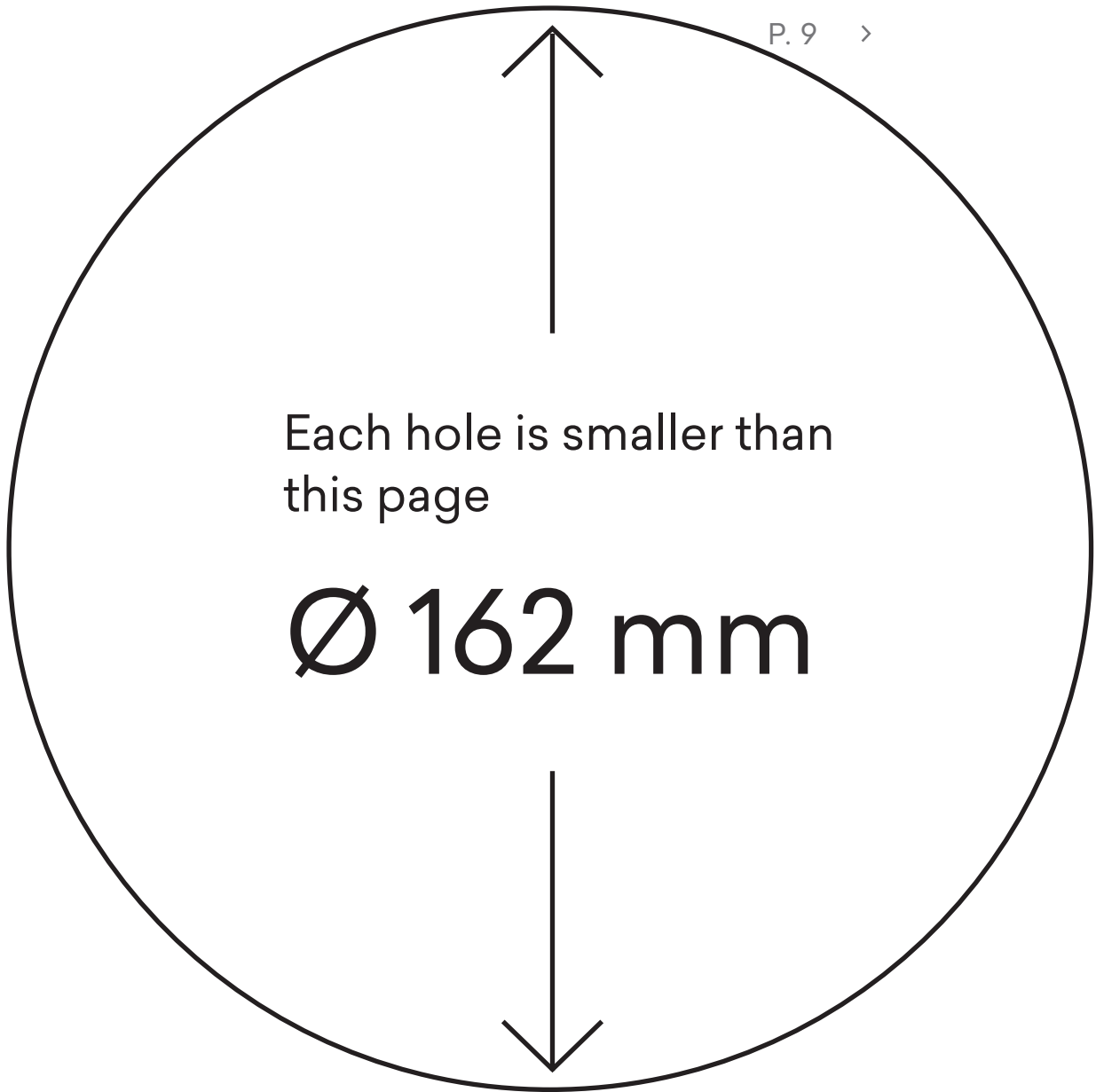



..2.0 MINI





## Form follows function, Hyper-compact design and no plastic

The minimum depth, the right colour, the perfectly smooth surface, the body made entirely of metal... a product designed to integrate perfectly into any domestic environment, giving excellent performance and at the same time... disappearing... in both horizontal and vertical developments, the design of ..2.0 has been carefully studied down to the smallest detail so as to combine form and function in a perfect symbiosis.

..2.0 has a 100% metal body that is strong and robust. In the design, the dimensions of the components have been reduced and optimised to include all the functions required for perfect operation within a hyper-compact design.

The depth? Just 16 centimetres. An ultra-thin thickness that minimises aesthetic impact, both inside and out.



..2.0 VERTICAL

..2.0 + FCU

..2.0

..2.0 MINI



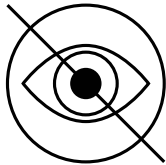

### **ALMOST INVISIBLE, INDOOR AND OUTDOOR**

With only 16 cm depth ..2.0 is extremely slim and unobtrusive. The aesthetic impact is limited, both indoor and outdoor.

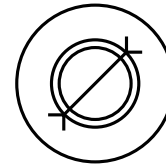

### **162 mm HOLES**

Important for both design and installation: easier to find drilling tools, no need for professional drills, even less aesthetic impact.



### **DC INVERTER AND DUAL POWER: OPTIMISED POWER, REDUCED CONSUMPTION**

Thanks to the DC Inverter technology, the powers are optimised so as to have the maximum comfort with the lowest consumption and noise. Thanks to Dual Power, you can use the maximum power of the machine to reach the required temperature in the shortest possible time. Once reached, the ..2.0 will automatically adjust itself in function of comfort.

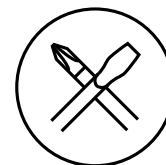

### **EASY INSTALLATION**

Installation accessories (template, support bracket, insulating wall pipes, outdoor grilles) are included in the package.





### “COOLING ONLY” AND “HEAT PUMP” IN THE SAME MODEL

..2.0 is in heat pump mode, with condensate drainage pipe. However, the “heating” function can be easily deactivated: the appliance operates in “cold only” mode, without the need for a condensate drain.

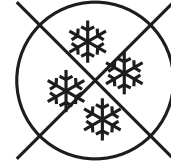

### NO FROST SYSTEM

In winter, during heat pump operation, the condensate drip tray is constantly preheated, so there is no risk of the water freezing.

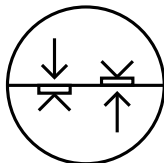

### SELF FOLDABLE OUTDOOR GRILLES

The folding grilles of ..2.0, operated by the inlet and outlet air, open when the unit is working and close when the unit is switched off. Better indoor comfort, less dust, noise and pollution. Lower maintenance, even less visibility outside.

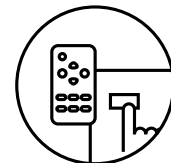

### CONTROL BOTH REMOTE AND ON BOARD

In addition to the remote control, the on-board control panel allows any function to be set, including a ‘lock’ function that prevents any inappropriate use. The APP allows complete management of the unit from a remote position, through WiFi.

# The versions



## ..2.0

The ..2.0 line has two major innovations in terms of power and size.

A MAXI 15 HP version and a MINI 9 HP version using R290 propane gas.



## ..2.0<sup>+</sup>FCU

With an integrated fancoil for heating with hot water from the system, in summer it works as a normal air conditioner, in winter it can operate as a heat pump, as a simple fancoil or in automatic hybrid mode when temperatures become particularly cold.





## ..2.0<sup>H2O</sup>

..2.0 H2O is the water-to-air air conditioner that can be connected to groundwater, mains water and closed-loop water. It can provide heat or cold depending on the season, at a constant water temperature. One of the most innovative technical solutions in the world of building renovation to restructure without intervening on existing pipes.



## ..2.0<sup>VERTICALE</sup>

The vertical version of ..2.0 is ideal when there is insufficient or no space of its own, for example between two French windows or near corners.

# ..2.0 MINI

## The tiny air conditioner



**WITHOUT OUTDOOR UNIT**  
The outdoor unit is replaced by two holes of 162 mm.



**EASY INSTALLATION**  
Monoblock unit without refrigerant connections during installation.



**81 CM WIDTH**



**R290 PROPANE GAS**





## So small, so ecological

..2.0 MINI is the first fixed double duct air conditioner to use R290 (propane) gas. An exceptional amount of R&D work has been carried out to ensure that the unit operates perfectly with less than 150 g of gas, the limit imposed by law.

..2.0 MINI has an environmental impact in terms of GWP (Global Warming Potential) of 3, compared to R410a gas which has a GWP of 2088 and R32 gas which has a GWP of 675.

When space is particularly tight, ..2.0 MINI fits in, thanks to a width of just 81 cm wide, while maintaining the same standards of performance and silence.

### Power range ..2.0 MINI

15 HP	-
12 HP	-
10 HP	-
9 HP	•
..2.0 MINI	



# ..2.0 MAXI

The ..2.0 with extra-large power



#### 202 MM HOLES

The outdoor unit is replaced by two holes of 202 mm.



#### EASY INSTALLATION

Monoblock unit without refrigerant connections during installation.



#### REFRIGERANT GAS R32



#### REMOTE CONTROL WITH INNOVAPP

# Never seen such a powerful ..2.0

When you need more power... now there's ..2.0 MAXI.  
 With 202 mm holes, and all other dimensions being equal, ..2.0 MAXI 15 HP delivers more power, while maintaining the same performance and noise standards.

## High power

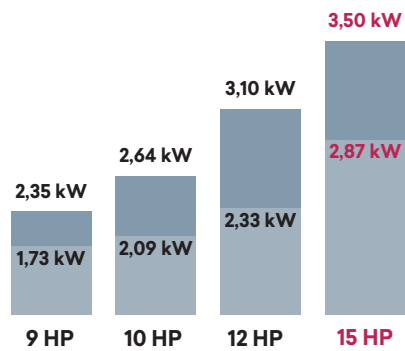

■ Maximum cooling capacity Dual Power  
■ Nominal cooling capacity

## Positioning

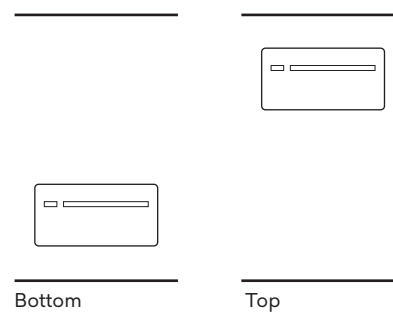

## More power, same easy installation.



# ..2.0

## Now a classic



### WITHOUT OUTDOOR UNIT

The outdoor unit is replaced by two holes of 162 mm.



### EASY INSTALLATION

Monoblock unit without refrigerant connections during installation.



### REFRIGERANT GAS R32



### REMOTE CONTROL WITH INNOVAPP



## Beautiful, slim and silent

Too often air conditioning means installing bulky and unsightly condensing units outside buildings. ..2.0 is the INNOVA air conditioner without external unit designed to fit perfectly into existing domestic environments, offering excellent energy performance and almost disappearing from view to minimise aesthetic impact. The design has been studied in every detail to create a true furnishing object, slim and compact, where form follows function.

..2.0 can operate both for summer air conditioning and, in heat pump mode, for winter heating. All, in the same model, with maximum simplicity of installation.

### Simple and practical

The ..2.0 in its standard version is the ideal solution for most living contexts and for the most common domestic needs. Simplicity at your fingertips.

### Power range ..2.0

15 HP	•
12 HP	•
10 HP	•
9 HP	-
	..2.0

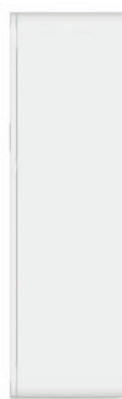

16 cm

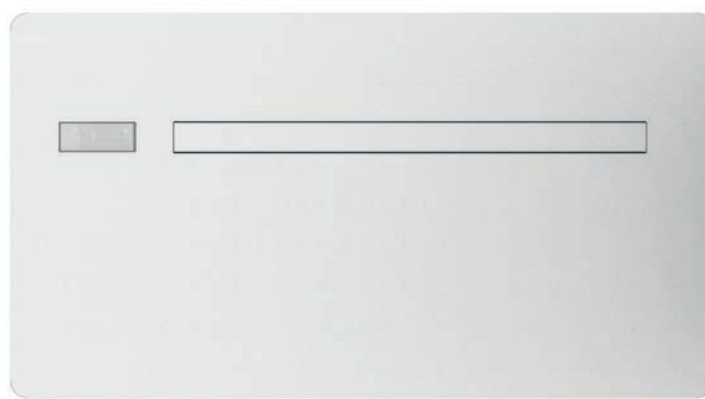

101 cm



..2.0



## Easy installation

Minimum depth, the right colour, the perfectly smooth surface, the all-metal body... a product designed to fit perfectly into any environment.

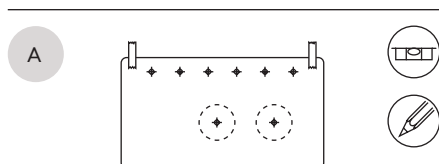
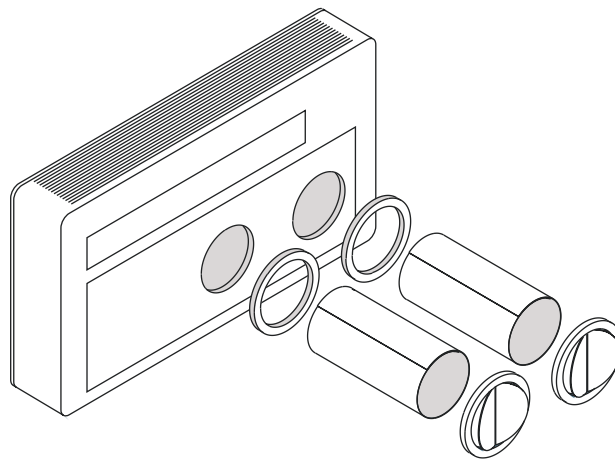

A Put the template on the wall and mark the positions of the bracket support screws and the two hole centres.

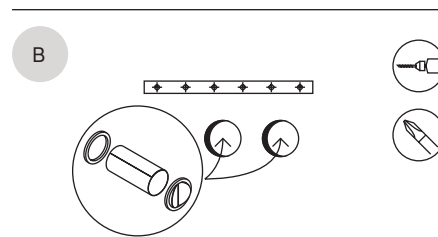

B Fix the bracket to the wall and insert the outdoor grilles, protection sheets and indoor counterflanges into the holes.

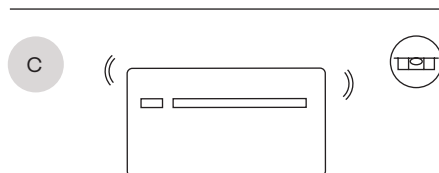

C Place the unit on the bracket, checking for correct horizontal and vertical alignment.

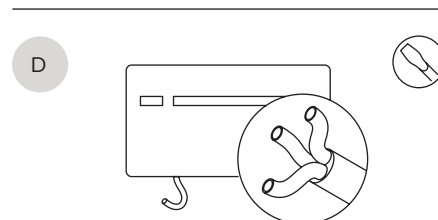

D Make the electrical and condensate drainage pipe connections for heat pump operation.



1

**FULLY METAL**

The body of ..2.0 is made entirely of metal, with all plastic parts removed. Strong and robust, ..2.0 is even more solid and consistent.

2

**TOUCH SCREEN DISPLAY + WIFI RECEIVER**

The large control panel allows you to select every operating parameter on board the machine - and also manage communication via WiFi.

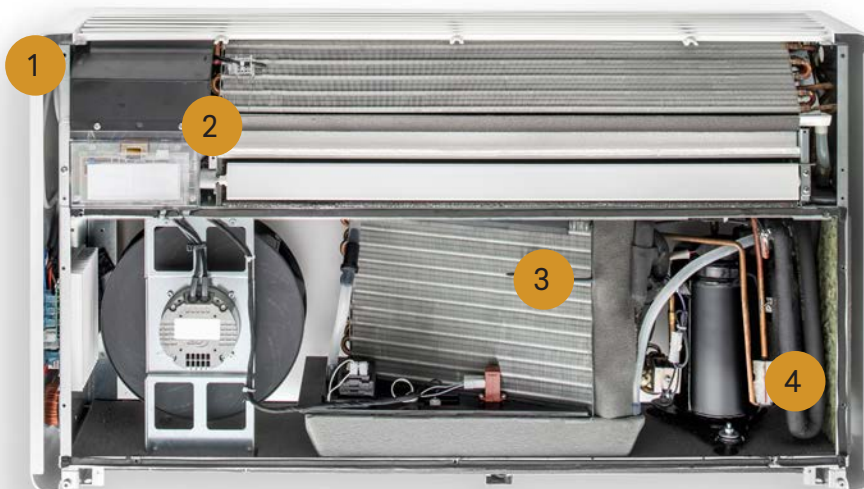

3

**HIGH-EFFICIENCY CONDENSING COIL**

The condensing coil is high-efficiency with an evaporative condensation system for even better performance.

4

**HYPER-COMPACT DESIGN**

A hyper-compact body includes everything necessary for the perfect functioning of the product thanks to meticulous design and study work with the aim of reducing the size of each component and ensuring its perfect functioning.

## ..2.0 ELEC, the ..2.0 with integrated electrical heater

As with all heat pumps, heating performance decreases as the outside temperature falls. Often the need is for a product that maintains sufficient performance even at very low external temperatures.

In ..2.0 ELEC, the heat pump is integrated (and not replaced) by a 900 W electric heater that intervenes automatically for very low outside temperatures or to heat very cold rooms quickly.

For this reason, ..2.0 ELEC can ensure a heating power of over 2 kW even at -7°C with an additional electrical absorption of 900 W compatible with the electrical power available in homes.

..2.0 ELEC thus becomes a true complete heating system even in particularly cold climates.

### Thermal performance comparison

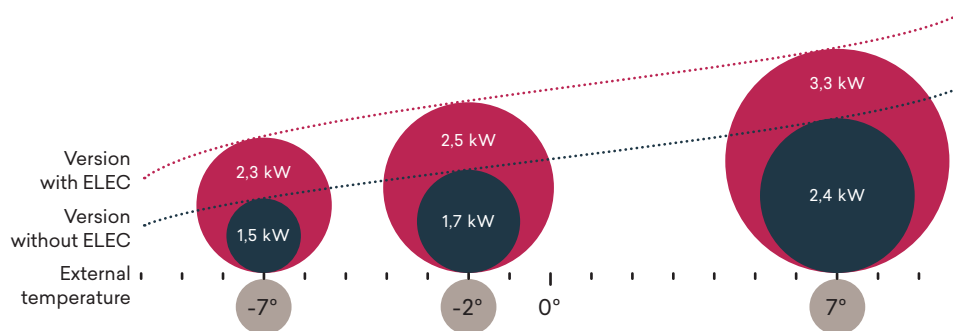



# ..2.0 + FCU

## The ..2.0 with integrated fancoil



### WITHOUT OUTDOOR UNIT

The outdoor unit is replaced by two holes of 162 mm.



### EASY INSTALLATION

Monoblock unit without refrigerant connections during installation..



### REFRIGERANT GAS R32



### REMOTE CONTROL WITH INNOVAPP





## Suitable for all seasons

With ..2.0 + FCU, an air conditioner for summer and winter operation and a fan coil for heating with hot water are integrated in a single housing. This means that a classic radiator can be replaced and summer and winter comfort can be achieved in return. Installation of ..2.0 + FCU is easy: just two 162 mm holes in the wall and simple connections to the existing water heating system.

In winter, heating is guaranteed by the heat pump operation; when outside temperatures drop, ..2.0 + FCU automatically integrates the heat pump operation with the use of the fancoil, thus ensuring that the set inside temperature is maintained.

In the presence of particularly cold outside temperatures, moreover, the heating function can be programmed with the sole use of hot water from the system.

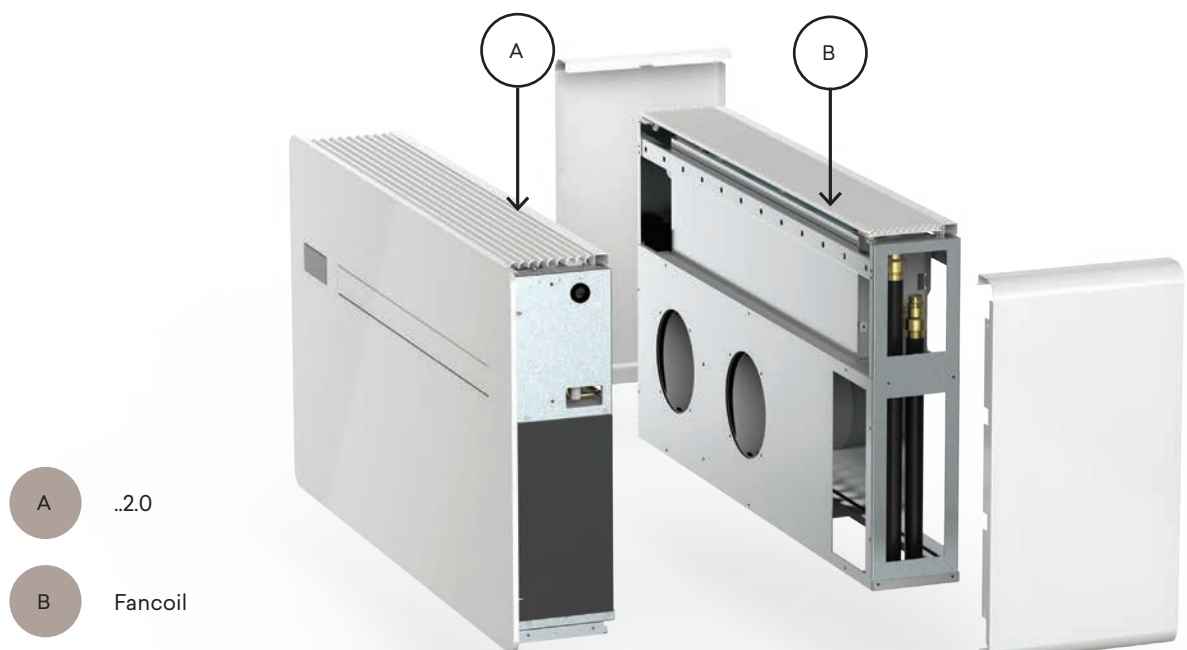

# ..2.0 H<sub>2</sub>O

## The water/air conditioner



### **WATER OPERATION**

Can be used with mains water, groundwater or WLHP loop system.



### **EASY INSTALLATION**

Monoblock unit without refrigerant connections during installation.



### **DC INVERTER AND DUAL POWER**

Maximum comfort with the lowest consumption and quietest operation.



### **REMOTE CONTROL WITH INNOVAPP**

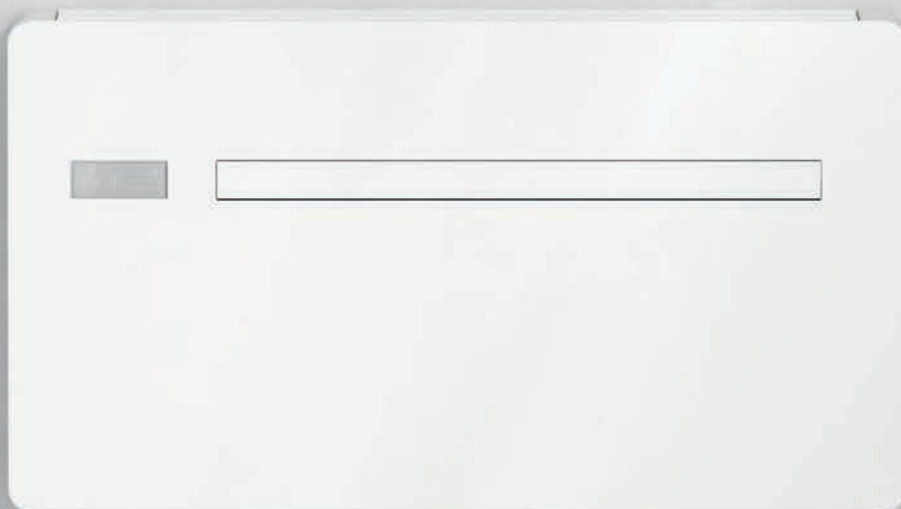

# Zero impact renovations

..2.0 H2O is an absolutely innovative solution in the world of building renovation.

In fact, ..2.0 H2O generates heat or cold according to the needs of the season, even in the presence of a water supply at a substantially stable temperature.

This means that it is possible to carry out renovation and energy requalification work without having to intervene on the existing pipes.

## High efficiency

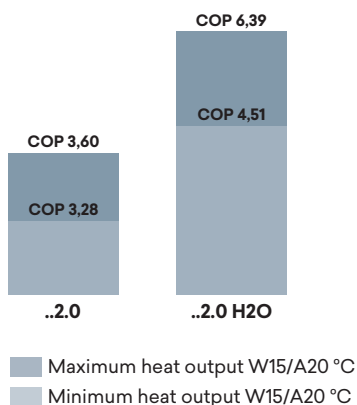

## Power range ..2.0 H2O

15 HP	•
12 HP	-
10 HP	-
9 HP	-
	..2.0 H2O

## Hot and cold, no problem

..2.0 H2O is the ideal air conditioner in particular domestic contexts such as historical centres and in general for the energy requalification of condominiums, where it is possible to remove the radiators and use the same pipes to have, thanks to ..2.0 H2O, both heating and cooling. ..2.0 H2O is installed as a traditional “water loop”, powered by a central heat pump.

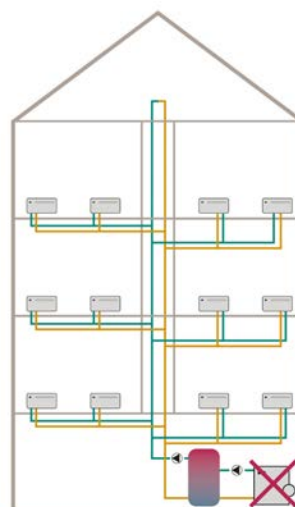

# ..2.0 VERTICAL

The vertical version of ..2.0  
ideal for when there's just  
no space.



**WITHOUT OUTDOOR UNIT**  
The outdoor unit is replaced by two  
holes of 162 mm.



**EASY INSTALLATION**  
Monoblock unit without refrigerant  
connections during installation.



**DC INVERTER AND DUAL POWER**  
Maximum comfort with the lowest  
consumption and quietest operation.



**REMOTE CONTROL WITH WIFI**

## The hyper-compact without an external unit

The vertical version of ..2.0 is just 500 mm wide and retains all the features of the standard model. It is the ideal solution for rooms where horizontal solutions are not permitted, for example between two windows or at an angle.

### Positioning

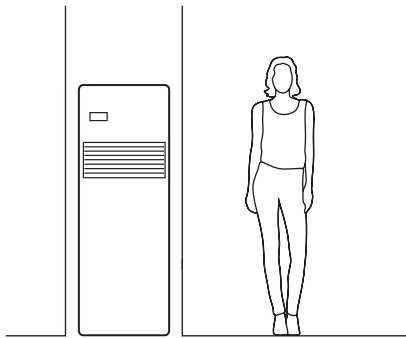

### Upward flow



# InnovApp

## Configure, manage and control all INNOVA devices

From summer to winter air conditioning, from heat pumps to fancoils, from VMC to radiant systems. InnovApp is the INNOVA application that allows customers to manage all elements of the home system with a simple touch, through their smartphone or tablet, from home or wherever they are. The InnovApp interface is easy and intuitive and allows you to create customised scenarios, set different temperatures in each room or for each ...2.0, fancoil or VMC, programming every detail of your home comfort.

### Remote and local management

Remotely - PC / Smartphone / Tablet

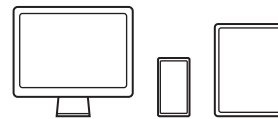

Local - Butler

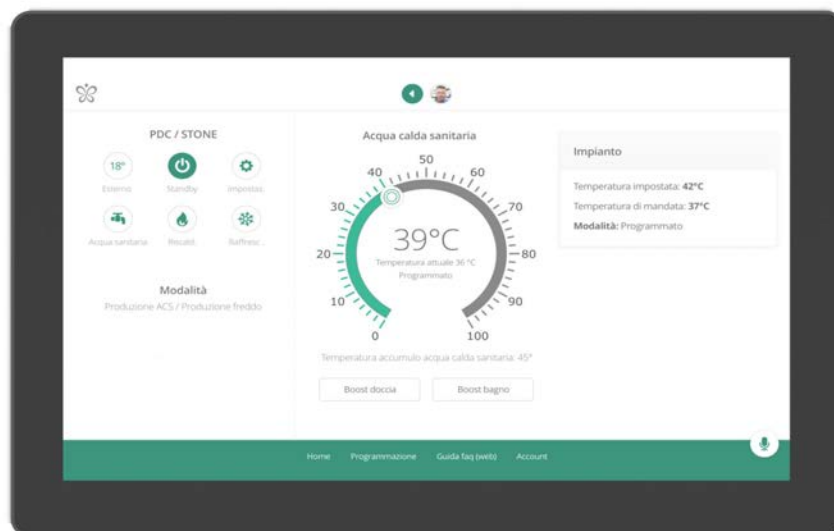



## Main functions

- **Supervision and control through local network or remote-ly**

The system can be managed through a smartphone, tab-let or computer

- **Summer and winter personalised programming**

Different programmes can be set for each season

- **Three temperature level setting on INNOVA fan coil net-work**

For each room or zone it is possible to select 3 different work temperatures, which can be modified at any time

- **Weekly time programming**

In each room it is possible to set different operating times

- **Network interface like the one on PCs**

The connection to the webserver is the same as that of a normal computer once the bus network between the heat pump and the fan coils has been established

- **Remote assistance**

With your consent, the ..2.0 can automatically log on to the INNOVA cloud for diagnostics and assistance when necessary

A

### WEEKLY SCHEDULING

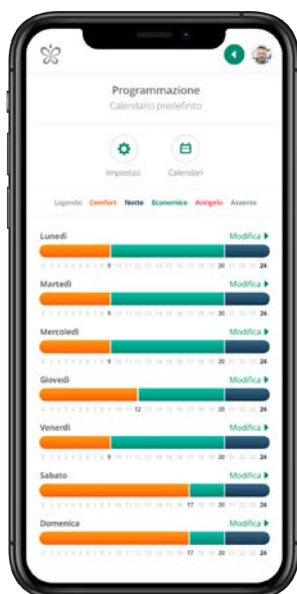

B

### DOMESTIC HOT WATER SETTINGS



## Side installation kit

Air conditioners without outdoor unit are always installed on a perimeter wall in order to exchange air with the outside.

In some cases this is not possible, the “outside” is lateral to the wall on which the unit is installed. With this new kit, to be embedded in the wall, the air flow is diverted laterally: it is therefore possible to install ..2.0 on the wall and have the air outlet on the side. This allows many new and unexpected installation possibilities!

- A ..2.0 for wall mounting.
- B Built-in side installation kit.
- C Self foldable outdoor grills.

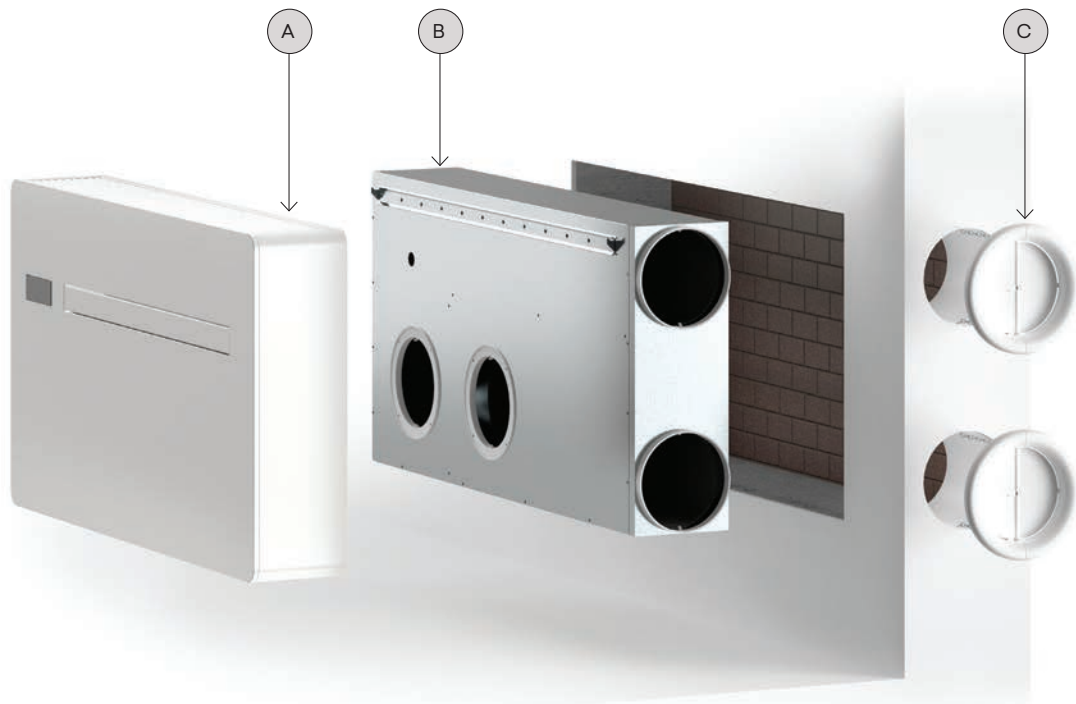
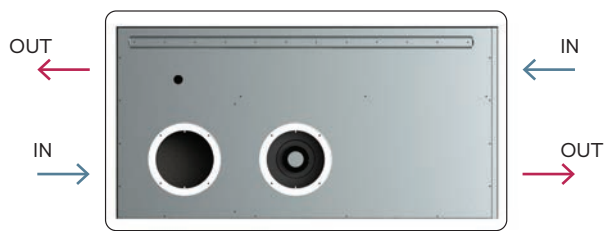



..2.0 - ..2.0 VERTICAL

# Accessory

## Kit of external grids with fixed fins.

### Description

Accessory supplied on request, as an alternative to the folding grills provided. The grids with fixed fins are in aluminium they are pre-ferred for aesthetic reason or for painting needs.

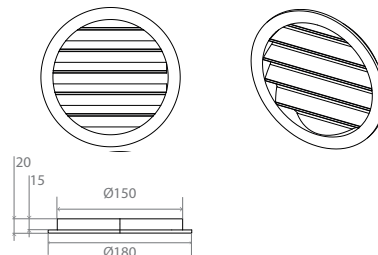

### Codes

**GB0738II** for ..2.0 horizontal / vertical and ..2.0+FCU  
**GB1091II** for ..2.0 whit 202 mm holes

## Rain protection kit.

### Description

Top cover of holes for installation of the ..2.0 on walls exposed to rain and wind. Accessory supplied on request and applicable on external grids with fixed fins.

The supply includes 2 covers, one for each grill.  
 White RAL 9003.

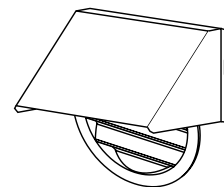

### Functionality

The accessory, positioned in the upper part of the grilles, protects the hole from bad weather.

### Codes

**GB0739II** for ..2.0 horizontal / vertical and ..2.0+FCU

## Insect protection kit.

### Description

Kit consisting of:

- 1 metal mesh discs
- 1 grids in metal wire
- fixing screws and plugs

Accessory supplied on request and applicable on external grids with fixed fins.

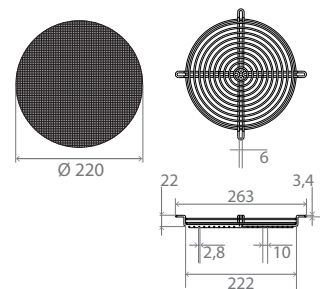

### Functionality

The accessory, installed above the grilles, further protects the holes avoiding the possible entry of insects or small materials.

### Codes

**GB0755II** for ..2.0 horizontal / vertical and ..2.0+FCU



## Pre-installation kit.

### Description

Kit consisting of:

- 2 external grilles for air inlet and outlet including springs and chains (A)
- 6 crews and dowels kit (B)
- Wall fixing bracket (C)
- Paper template for drilling holes (F)
- 2 wall-mounted pipes (H)
- Installer manual (N)
- Counter-flange for internal wall (O)

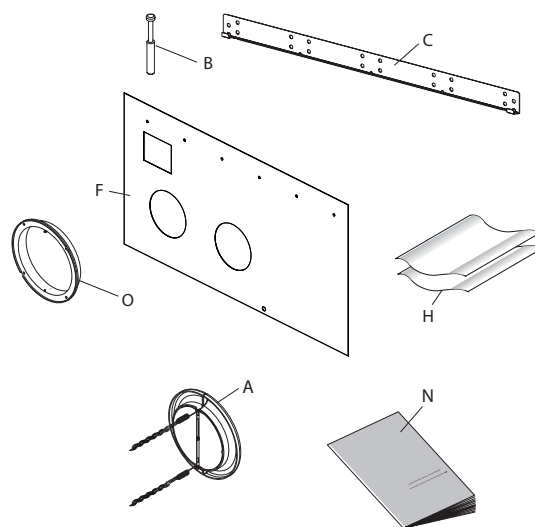

### Functionality

This kit is used to prepare the space and holes for the future installation of the ..2.0. All components of this accessory are still included in the box at the time of purchase.

### Codes

- GB0671II** for ..2.0 horizontal with 162 mm holes  
**GB1092II** for ..2.0 horizontal with 202 mm holes  
**GB1109II** for ..2.0 MINI

## Kit for installation on glass walls.

### Description

Kit consisting of:

- 1 aesthetic back cover, white colour RAL 9003
- 2 floor fixing bracket for ..2.0
- 1 front plinth cover floor fixing brackets RAL 9003
- Screws and nuts

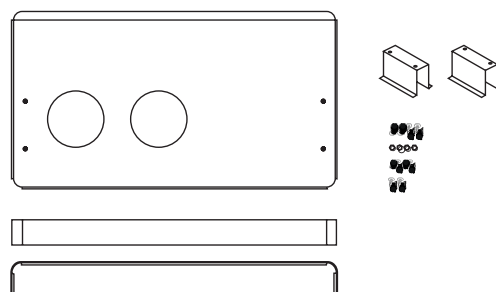

### Functionality

The accessory has an aesthetic function in installation where the back of the ..2.0 is visible. For example when it is placed behind a display cabinet.

### Codes

- GB0740II** for ..2.0 horizontal  
**GB0742II** for ..2.0 H2O

## UV-C lamp kit.

### Description

Air sterilization device with UV-C lamp (1)

For use in combination with horizontal ..2.0 12 HP size only

(1) Accessories can be installed and tested at the factory

### Codes

- GB1104II** for ..2.0 horizontal  
**GR1232II** Spare UV-C lamp kit for horizontal ..2.0

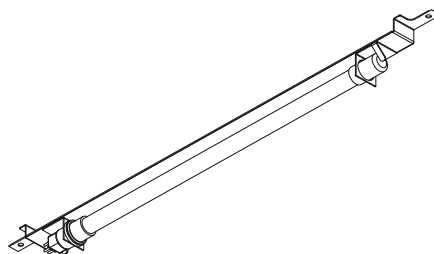

## Aesthetic kit lower side cover ..2.0.

### Description

The lower side cover is made of galvanised sheet metal painted in the same colour as the unit.

### Functionality

The accessory has an aesthetic function in installations where the lower part of the luminaire is visible, such as overhead installations.

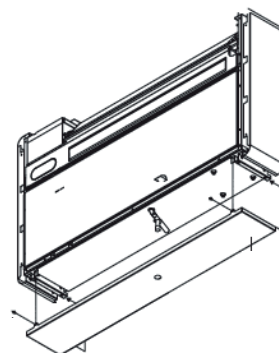

### Codes

**GB0737II** for ..2.0 horizontal and H2O  
**GB1105II** for ..2.0 MINI

## Modulating valve kit.

### Description

The modulating valve reduces the consumption of the water used and extends the operating range for domestic hot water.

### Functionality

The valve controls the water flow rate according to its inlet temperature. Example: If in cooling mode the water temperature is  $<20^{\circ}\text{C}$ , the valve reduces the flow rate to obtain an outlet temperature ( $35^{\circ}\text{C}$ ) that allows a correct condensation temperature. In heating mode, if the water temperature is too hot, the valve reduces the flow rate to obtain an outlet temperature of  $7^{\circ}\text{C}$ .

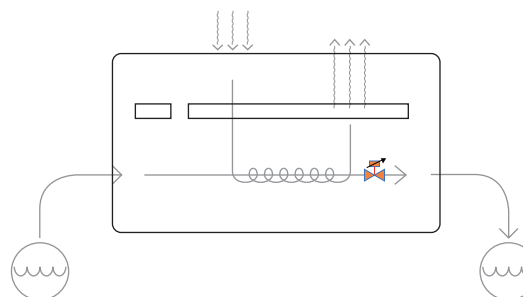

### Codes

**GB1018II** for ..2.0 H2O

## Kit “Fresh Air” with heat recovery.

### Description

Kit consisting of:

- 1 “Punctual” HRV with ceramic recuperator
- 1 electrical box to be positioned inside the ..2.0

### Functionality

The kit allows to incorporate the heat recovery ventilation in the air-conditioning, reducing everything in a single space. The renewal air flow is  $24\text{ m}^3/\text{h}$  with alternating flow.

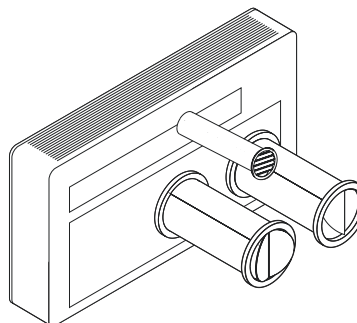

### Codes

**GR0765II** for ..2.0 horizontal





# Electronic controllers for ..2.0

## Display touch screen

Supplied as standard on board.

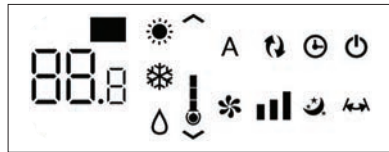

- Interface:**
- Touch interface
  - Modulating fan speed
- WiFi connection in DC Inverter versions

- Functionality:** All mode settings, temperature and special functions
- Different operating modes: cooling only, dehumidification only, ventilation only, heating only.

## Remote control

Supplied as standard.

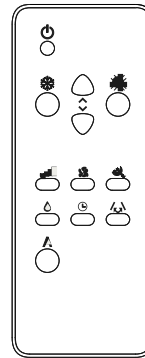

- Possibility to control the airflow direction
- Night well-being key
- Fan speed control
- Timer function setting

## Smart Touch wall control.

- Touch interface
- Modulating fan speed
- Cable length 8 m
- Integrated WiFi



- WiFi icon cod: **ECA031II**
- WiFi icon cod: **ECB031II**

- Touch interface
- Modulating fan speed
- Cable length 8 m
- Integrated Modbus port



- cod: **ECA032II**
- cod: **ECB032II**

Simplified operation with basic control and unit setting functions

- Seasonal setting
- Temperature set point
- Ventilation speed

# Technical data sheets

		..2.0 MINI	..2.0	..2.0 VERTICAL	..2.0	..2.0 ELEC	..2.0 VERTICAL	..2.0 MAXI	..2.0 H2O
Model	u.m.	9 HP	10 HP		12 HP			15 HP	15 HP

## Cooling performance (A 35 °C; A 27 °C)

Maximum cooling capacity Dual Power	(1)	kW	2,35	2,64	2,60	3,10	3,10	3,11	3,50	3,60 (5)
Nominal cooling power	(1)	kW	1,73	2,09	2,04	2,33	2,35	2,35	2,87	2,66 (5)
Minimum Cooling Capacity	(1)	kW	0,70	0,83	0,81	0,92	0,92	0,92	1,40	1,30 (5)
Dehumidification capacity		L/24h	0,7	0,8	0,8	0,9	0,9	0,9	1,2	1,3
Total input power		kW	0,57	0,64	0,75	0,72	0,73	0,85	1,04	0,73 (5)
EER			3,01	3,29	2,72	3,25	3,25	2,75	2,74	4,32
Energy efficiency class	(2)		A	A+	A	A+	A+	A	A	-

## Heating performance (A 7 °C; A 20 °C)

Maximum heat output Dual Power	(3)	kW	2,40	2,64	2,64	3,05	3,05	3,05	3,50	3,84 (6)
Nominal heat power	(3)	kW	1,71	2,08	2,10	2,31	2,31	2,36	2,75	2,80 (6)
Electric heater additional power		kW	-	-	-	-	0,90	-	-	
Minimum heat output	(3)	kW	0,75	0,71	0,68	0,79	0,79	0,79	1,35	1,40 (6)
Total absorbed power	(3)	kW	0,54	0,63	0,67	0,71	0,71	0,75	0,88	0,72 (6)
COP			3,15	3,31	3,10	3,28	3,28	3,15	3,12	4,31
Energy class			A	A	A	A	A	A	A	-

## Electrical data

Total input power		kW	0,90	0,95	0,95	1,06	1,96	1,06	1,45	1,06
Maximum absorbed current		A	3,90	4,10	4,40	4,60	8,50	4,80	6,30	5,60
Tension		V/F/Hz	230-1-50	230-1-50	230-1-50	230-1-50	230-1-50	230-1-50	230-1-50	230-1-50

## General characteristics

Indoor/outdoor ventilation speed		Nr.	3	3	3	3	3	3	3	3
Air flow at the maximum fan speed internal/external		m³/h	360/430	380/460	380/460	400/480	400/480	400/480	450/550	400
Air flow at the medium fan speed internal/external		m³/h	300/360	310/380	310/380	320/390	320/390	320/390	350/460	320
Air flow at the minimum fan speed internal/external		m³/h	240/320	260/330	260/330	270/340	270/340	270/340	300/400	270
Type of compressor			Rotary - DC Inverter							

## Sound data

Nominal sound pressure	(4)	dB(A)	39	39	39	41	41	41	43	41
Pressione sonora minima	(4)	dB(A)	27	26	26	27	27	27	29	27



		..2.0 MINI	..2.0	..2.0 VERTICAL	..2.0	..2.0 ELEC	..2.0 VERTICAL	..2.0 MAXI	..2.0 H2O
Modelli	u.m.	9 HP	10 HP		12 HP			15 HP	15 HP

### Refrigeration connections

Refrigerant		R290	R32	R410a	R32	R32	R410a	R32	R410a
Refrigerant charge		0,14	0,50	0,56	0,50	0,50	0,56	0,50	0,75

### Hydraulic data

Water flo	L/h	-	-	-	-	-	-	-	660
Hydraulic connections	" EK	-	-	-	-	-	-	-	3/4

### Product dimensions and weight

Total width	mm	810	1010	500	1010	1010	500	1010	1010
Total height	mm	549	549	1398	549	549	1398	549	549
Total depth	mm	165	165	185	165	165	185	165	165
Empty weight	kg	38,0	41,0	57,0	41,0	41,0	57,0	41,0	50,0
Wall hole diameter	mm	162	162	162	162	162	162	202	-
Hole spacing on wall	mm	293	293	293	293	293	293	293	-

### Option with FCU combination

Total heat capacity FCU (70 °C)	kW	-	1,9	-	1,9	-	-	-	-
Water flow	L/h	-	364	-	364	-	-	-	-
Water pressure drop	KPa	-	10	-	10	-	-	-	-
Hydraulic connections	" EK	-	3/4	-	3/4	-	-	-	-
Total width	mm	-	1010	-	1010	-	-	-	-
Total height	mm	-	549	-	549	-	-	-	-
Total depth	mm	-	308	-	308	-	-	-	-

- (1) Outdoor air temperature 35°; relative humidity 41%. Ambient air temperature 27°C; relative humidity 47%. Performance according to EN 14511
- (2) Energy classification according to Directive 626/2011
- (3) Outdoor air temperature 7 °C; relative humidity 87% / Ambient temperature 20 °C, relative humidity 59% / Performance according to EN 14511
- (4) Sound pressure level on the system side measured in a semi-anechoic chamber at a distance of 2 m
- (5) Water in/out temperature 30/35 °C / Ambient temperature 27 °C; Relative humidity 50% / Performance according to EN 14511
- (6) Water in/out temperature 15/10 °C / Ambient temperature 20 °C; Relative humidity 28% / Performance according to EN 14511

#### Operating Limits:

Min. cooling temperature T environment 18°C / T external -5 °C  
 Max. cooling temperature T environment 32°C / T external 43 °C  
 Min. heating temperature T environment 5 °C / T external -10 °C  
 Max. heating temperature T environment 25 °C / T external 18 °C

#### Operating Limits for ..2.0 H2O:

Min. heating source temperature 10°C with min. output temperature 7°C  
 Max. source temperature in heating mode 25°C  
 Min. source temperature in cooling mode 20°C  
 Max. source temperature in cooling mode 40°C

Recommended working range for inlet water temperature: 15±25 °C in heating and 15±35 °C in cooling. Ideal inlet conditions 20 °C heating and 30 °C cooling.







..2.0

#### CREDITS

Product Designer

**Luca Papini**

Art Direction & Graphic

**Osmo Design**

Photography

**Ottavio Tomasini**

Special thanks to:

**Akira Nishikawa**

© All rights reserved - photographs, images and texts are protected by copyright, any use of all or part of them not expressly authorised by INNOVA will result in consequent sanctions.

INNOVA reserves the right to make changes at any time to its products, accessories and technical data in order to improve its offer.





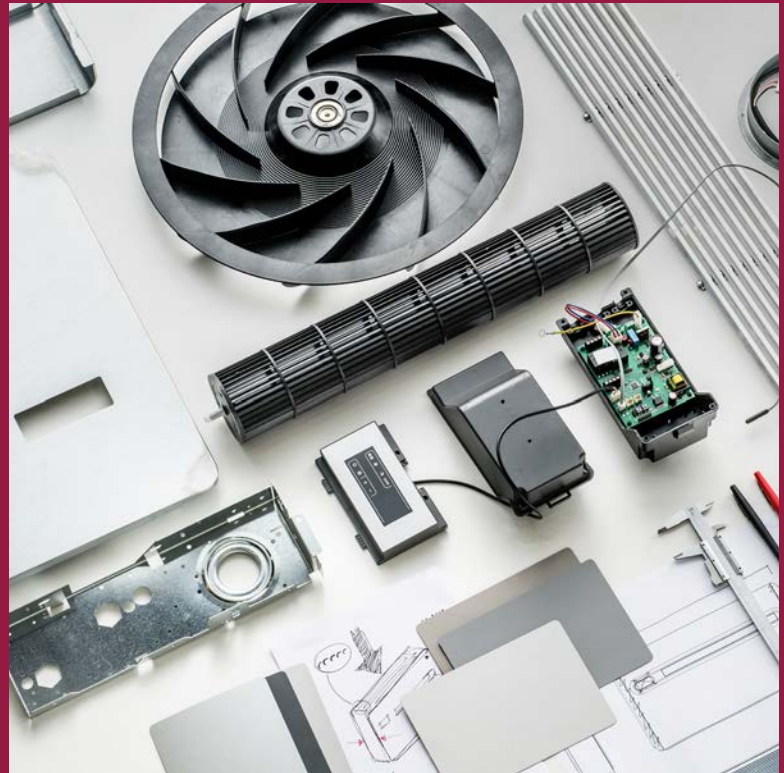

We turn ideas into products.





**INNOVA s.r.l.**  
Via 1° Maggio, 8  
38089 Storo (Tn)  
Tel. +39 0465 670104  
Fax: +39 0465 674965  
info@innovaenergie.com

[www.innovaenergie.com](http://www.innovaenergie.com)

Edition 2022/1