

User's manual
(Translation of original
instructions)

EN



innova

N420944A - Rev.00 - 06/23

>OSMO<

ECA844 - EEB749 - EGB749 -
B10842 - B4V842 - B3V151

First of all, we would like to thank you for having chosen a device of our production.

We are sure you will be happy with it because it represents the state of the art in the technology of home air conditioning.

By following the suggestions contained in this manual, the product you have purchased will operate without problems giving you optimum room temperatures with minimum energy costs.

INNOVA S.r.l.

Conformity

Refer to the Installation Manual of the paired unit.

Markings



TABLE OF CONTENTS

1	Coding	<u>p. 5</u>
1.1	Coding accessories	<u>p. 5</u>
2	General information	<u>p. 6</u>
2.1	About the manual.	<u>p. 6</u>
2.1.1	Editorial pictograms	<u>p. 6</u>
2.1.2	Pictograms on the product.	<u>p. 6</u>
2.1.3	Recipients	<u>p. 6</u>
2.1.4	Manual organisation	<u>p. 6</u>
2.2	General warnings	<u>p. 7</u>
2.3	Disposal.	<u>p. 7</u>
3	Unit with touchpad and remote control	<u>p. 8</u>
3.1	Interface	<u>p. 8</u>
3.1.1	Description	<u>p. 8</u>
3.1.2	Touchscreen display	<u>p. 8</u>
3.1.3	Remote control.	<u>p. 9</u>
3.2	Main functions.	<u>p. 9</u>
3.2.1	General start-up	<u>p. 9</u>
3.2.2	Put in stand-by the control.	<u>p. 9</u>
3.2.3	Set room temperature	<u>p. 9</u>
3.2.4	Heating only mode	<u>p. 10</u>
3.2.5	Cooling only mode	<u>p. 10</u>
3.2.6	Functioning in automatic mode.	<u>p. 10</u>
3.2.7	Functioning in maximum mode.	<u>p. 10</u>
3.2.8	Minimum mode operation	<u>p. 10</u>
3.2.9	Set the direction of the air flow	<u>p. 10</u>
3.2.10	Set the key lock.	<u>p. 10</u>
3.3	Basic menu.	<u>p. 10</u>
3.3.1	Menu items	<u>p. 10</u>
	Set AIR probe offset.	<u>p. 10</u>
3.3.2	Scale	<u>p. 11</u>
3.3.3	Adjusting buzzer volume	<u>p. 11</u>
3.4	Warnings	<u>p. 11</u>
3.4.1	Operating the unit if the remote control is not available	<u>p. 11</u>
3.4.2	Troubleshooting	<u>p. 11</u>
3.4.3	Visualization of alarms on display	<u>p. 11</u>
3.4.4	Reset filter cleaner alarm	<u>p. 11</u>
4	M7 series controls EEB749 - EFB749 - EGB749	<u>p. 12</u>
4.1	Interface	<u>p. 12</u>
4.1.1	Description	<u>p. 12</u>
4.1.2	Display	<u>p. 12</u>

4.1.3	Keys functions	<u>p. 12</u>
4.2	Main functions.	<u>p. 13</u>
4.2.1	General start-up	<u>p. 13</u>
4.2.2	Put in stand-by the control.	<u>p. 13</u>
4.2.3	Set room temperature	<u>p. 13</u>
4.2.4	Cooling only mode	<u>p. 13</u>
4.2.5	Heating only mode	<u>p. 13</u>
4.2.6	Automatic operation	<u>p. 13</u>
4.2.7	Minimum mode operation	<u>p. 13</u>
4.2.8	Maximum ventilation speed	<u>p. 13</u>
4.2.9	Set the key lock.	<u>p. 13</u>
4.3	Basic menu.	<u>p. 13</u>
4.3.1	Menu items	<u>p. 14</u>
4.3.2	Set AIR probe offset.	<u>p. 14</u>
4.3.3	Set probe offset RH	<u>p. 14</u>
4.3.4	Set the humidity setpoint	<u>p. 14</u>
4.3.5	Setting the humidity hysteresis.	<u>p. 14</u>
4.3.6	Scale	<u>p. 14</u>
4.3.7	Adjusting buzzer volume	<u>p. 14</u>
4.4	Warnings	<u>p. 14</u>
4.4.1	Long period shut-down	<u>p. 14</u>
4.4.2	In case of control blockage	<u>p. 14</u>
4.4.3	Visualization of alarms on display	<u>p. 15</u>
4.4.4	Reset filter cleaner alarm	<u>p. 15</u>

5 Troubleshooting p. 16

5.1	Preliminary warnings.	<u>p. 16</u>
5.2	Troubleshooting table	<u>p. 16</u>

6 Maintenance p. 17





6.1	Preliminary warnings.	<u>p. 17</u>
6.2	Routine maintenance.	<u>p. 17</u>
6.2.1	External cleaning	<u>p. 17</u>
6.3	Air intake filter cleaning	<u>p. 17</u>
6.4	Suggestions for energy saving	<u>p. 18</u>

CODING

⚠ The present manual refers to the products:

- >OSMO< SL
- >OSMO< RS

1.1 Coding accessories





	Accessory description	Combinable products	Code
Controls on the appliance			
M7 controls			
	M7 on-board electronic control with continuously modulating thermostat	All	ECA844II
	M7 on-board electronic control with continuously modulating thermostat, with built-in WiFi module.	All	EWA844II
Wall-mounted control panels M7 series			
Printed circuit board M7			
	Electronic board on board unit with continuous modulation. For connection to M7 wall control units	All	ESE845II
	Electronic board on board unit with continuous modulation. For connection to M7 wall control with Bluetooth	All	ESE846II
Control panels			
	LED electronic control panel with touch interface, wall-mounted complete with thermostat and room temperature and relative humidity probe. Cable connection. Colour white	All	EEB749II
	LED electronic control panel with touch interface, wall-mounted complete with thermostat and room temperature and relative humidity probe with integrated WiFi module, InnovAPP. Cable connection. Colour white	All	EFB749II
	LED electronic control panel with touch interface, wall-mounted complete with thermostat and room temperature and relative humidity probe. Bluetooth connection. Colour white	All	EGB749II
WALL MOUNTED STANDARD FANCOIL CONTROLS			
PCB			
	On-board electronic printed circuit board for control from systems with 0-10 V analogue output.	All	B10842II
	On-board electronic printed circuit board for connection to 3-speed wall-mounted electromechanical thermostats.	All	B4V842II
Control panels			
	Wall mounted control with thermostat, summer/winter and speed selectors	All	B3V151II
Reversal attacks			
(motor connection cable for LEFT hydraulic connections			
	Hydraulic connection reversal kit	All	BB0646II (1)

1. Accessories can be installed and tested at the factory

GENERAL INFORMATION

2.1 About the manual





This manual was written to provide all the explanations for the correct management of the appliance.

-  This instruction manual forms an integral part of the device and therefore must be carefully preserved and must ALWAYS travel with it, even if you transfer the device to another owner or relocate it to other premises. If the manual gets damaged or lost, download a copy from the website.
-  Read this manual carefully before proceeding with any operation and follow the instructions in the individual chapters.
-  The manufacturer is not responsible for damages to persons or property caused by failure to follow the instructions in this manual.
-  This document is restricted in use to the terms of the law and may not be copied or transferred to third parties without the express authorization of the manufacturer.

2.1.1 Editorial pictograms

The pictograms in the next chapter provide the necessary information for correct, safe use of the machine in a rapid, unmistakable way.

Related to security

-  **High risk warning (bold text)**
 - The operation described above presents a risk of serious physical injury, fatality, major damage to the appliance and/or to the environment if not carried out in compliance with safety regulations.
-  Low risk warning (plain text)
 - The operation described above presents a risk of minor physical injury or minor damage to the appliance and/or to the environment if not carried out in compliance with safety regulations.
-  Prohibition (plain text)
 - Refers to prohibited actions.
-  **Important information (bold text)**
 - This indicates important information that must be taken into account during the operations.



In the texts

- procedures
- lists

In the control panels

- actions required
- Expected responses following an action.*

In the figures

- 1 The numbers indicate the individual components.
- A The capital letters indicate component assemblies.
-  The white numbers in black marks indicate a series of actions to be carried out in sequence.
-  The black letter in white identifies an image when there are several images in the same figure.

2.1.2 Pictograms on the product

Symbols are used in some parts of the appliance:

Related to security

Caution: electrical danger

- The concerned personnel is informed to the presence of electricity and the risk of suffering an electric shock.

2.1.3 Recipients

User

Non-expert person capable of operating the product in safe conditions for people, for the product itself and the environment, interpreting an elementary diagnostic of faults and abnormal operating conditions, carrying out simple adjustment, checking and maintenance operations.

Installer

Expert person qualified to position and connect (hydraulically, electrically, etc.) the unit to the plant; this person is responsible for handling and correct installation according to the instructions provided in this manual and the national standards currently in force.

Technical Service Centre

Expert and qualified person authorised directly by the manufacturer to carry out all routine and supplementary maintenance operations, as well as every adjustment, check, repair and replacement of parts necessary during the life of the unit itself.

2.1.4 Manual organisation

The manual is divided into sections each dedicated to one or more target groups.

Coding

It addresses all recipients.

It contains the list of products and/or accessories referred to in the manual.

General information

It addresses all recipients.

It contains general information and important warnings that should be known before installing and using the appliance.

Control panels

It addresses all recipients.

It contains section by control mode and information on the use of the main functions.

App

It addresses all recipients.

It contains useful information for the control of the unit via the app for mobile and the use of main functions.

Maintenance and Troubleshooting

It addresses all recipients.

It contains specific warnings and useful information for regular maintenance work.

2.2 General warnings

- ⚠ This instruction is an integral part of the booklet of the appliance.
- ⚠ The manufacturer reserves the right to make changes to its models at any time to improve its product, without prejudice to the essential characteristics described in this manual. The manufacturer is not obliged to add such modifications to machines previously manufactured, already delivered or under construction.
- ⚠ All repair or maintenance interventions must be performed by the technical service department or by professionally qualified personnel as foreseen in this booklet. Do not modify or intervene on the appliance as this could create dangerous situations and the manufacturer will not be responsible for any damage caused.
- ⚠ Objects or structural obstacles (furniture, curtains, plants, leaves, blinds, etc.) must not obstruct the normal air flow both from the internal and from the external grids.
- ⚠ Do not put any containers on top of the appliance, especially if they contain liquids, as this could cause a short circuit or cause damage to the appliance and/or be exposed to danger of electrocution.
- ⚠ Do not lean on the appliance.
- ⚠ In the event of water leaks, turn off the appliance and disconnect the electric power supply. Call the Technical Service Centre.
- ⚠ In case of replacement of parts, use only original parts.

2.3 Disposal

The symbol on the product or its packaging indicates that the product must not be treated as normal household waste, but must be taken to the appropriate collection point for the recycling of electrical and electronic equipment.

Proper disposal of this product avoids harm to humans and the environment and promotes the reuse of valuable raw materials.

For more detailed information about the recycling of this product, contact your local city office, your household waste disposal service or the shop where you purchased the product.

Illegal disposal of the product by the user involves the application of the administrative sanctions provided for by the regulations in force.

This provision is only valid in the EU Member States.

UNIT WITH TOUCHPAD AND REMOTE CONTROL

3.1 Interface

3.1.1 Description

⚠ The solution with touch pad and remote control is recommended for the prevalent use in cooling.

The display on the appliance allows you to:

- show the operating status
- show any alarms
- select the various functions by pressing on the symbols

The remote control allows you to:

- select the various functions by pressing on the symbols

⚠ The remote control supplied with the device is designed to provide maximum sturdiness and exceptional functionality, but should nonetheless.

⚠ The keys of the remote control and touch-screen display perform the same function.

⚠ It is possible to access the basic menu and the settings menu also via the remote control.

⚠ Handle with care.

⚠ Warnings:

- do not expose the remote control to rain or contact with liquids
- do not expose the remote control to direct sunlight
- handle with care avoiding strong impacts or falling on hard surfaces
- do not place obstacles between the remote control and the device while you are using the remote

⚠ If other devices are being used within the premises that are operated by remote control (TVs, radios, stereos, etc.), you might experience some interference.

⚠ Electronic and fluorescent lamps can interfere with communications between the remote control and the device.

⚠ Electronic and fluorescent lamps can interfere with communications between the remote control and the device.

3.1.2 Touchscreen display

Keys and functions related.

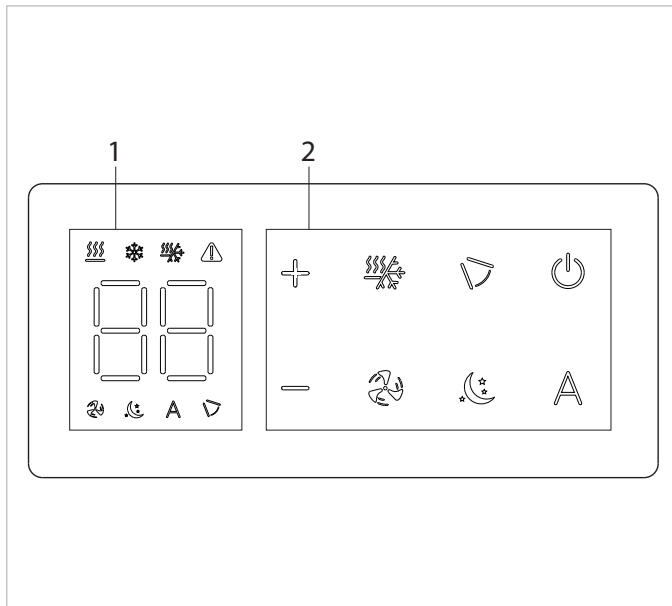

1.	Display area
2.	Keys area
	Setpoint
	Temperature value increase function
	Temperature value decrease function
	Power / Standby
	Alarm signals
	Flap control function
	Maximum mode
	Heating / Cooling (Cannot be used)
	Cooling function
	Heating function
	Auto Mode
	Minimum mode

3.1.3 Remote control

Keys and functions related.

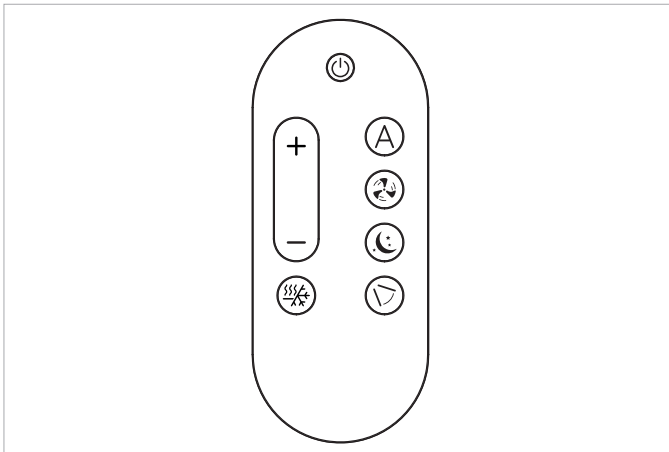

	Temperature value increase function
	Temperature value decrease function
	Power / Standby
	Auto Mode
	Maximum mode
	Minimum mode
	Flap control function
	Heating / Cooling

Inserting the battery

⚠ Use only a dry 3 V lithium battery CR2430 (included) with the remote control.

To insert the battery:

- open the slot on the bottom of the remote control

- insert the battery according to the +/- polarity
- close the cover after inserting the battery

⚠ Used batteries must be disposed of appropriately (WEEE) through special waste collection centres provided by the local authorities.

3.2 Main functions

⚠ The keys of the remote control and touchpad perform the same function.

⚠ It is possible to access the basic menu and the settings menu also via the remote control.

3.2.1 General start-up

To control the device with the remote control or touch-screen display:

- insert the power plug of the unit into the power socket of the system
- or switch on the main switch provided on the power supply line

After you perform these steps, you can operate the system either by pressing the symbols on the touch-screen display or using the remote control.

Correct use of the remote control:

- point the front of the remote towards the unit's display, the buzzer will emit a beep and a message will appear on the display to confirm that the command has been enabled
- the maximum range to send commands is about 8 metres

To activate the touchpad

- keep the key pressed for 2 seconds
The text appears on the display.
The device turns on.
The preset set-point appears on the 3 digits of the display.

⚠ The control panel has its own memory, therefore no settings will be lost in case of shut-down or power outage (except ventilation). The button in question is used to switch the appliance on and off for short periods.

⚠ If you plan to keep the device out of service for a prolonged time, remember to deactivate it by disconnecting the power or removing the power plug.

3.2.2 Put in stand-by the control

To put in stand-by the control

- press the key for about 2 seconds
The symbol appears
The control goes out.

⚠ The control panel has its own memory, therefore no settings will be lost in case of shut-down or power outage.

⚠ If you plan to keep the device out of service for a prolonged time, remember to deactivate it by disconnecting the power or removing the power plug.

To re-activate the control

- press the key for about 2 seconds
The device turns on and appears

3.2.3 Set room temperature

To set the setpoint

- use the keys to increase or decrease the desired value
The displayed value change.



⚠ The adjustment range goes from 16 to 28 °C, with a resolution of 1 °C.

⚠ Out of range values from 5 °C and 40 °C are allowed, except in automatic mode. These value should be set only for short periods of time.

⚠ Do not set a temperature that is too low or too high is harmful to health and is an unnecessary waste of energy.

3.2.4 Heating only mode



To select the Heating operation

- press  for about 2 seconds
The symbol  on indicates the Heating function enable.
The device heats the room.

⚠ In heating function the symbols is alight with setpoint higher than the room temperature.

3.2.5 Cooling only mode



To select the Cooling operation

- press  for about 2 seconds
The lighted  symbol in the display area indicates that the Cooling function is activated.
The device dehumidifies and cools the room.

⚠ In cooling function the symbols is alight with setpoint lower than the room temperature.

3.2.6 Functioning in automatic mode



To select functioning in automatic mode

- press the key 
The symbol  on indicates that fan operation in automatic mode.

⚠ The ventilation speed is set automatically.

3.2.7 Functioning in maximum mode

To select maximum mode operation

- press the key 
The lighted  symbol on the display indicates fan operation in maximum mode.

⚠ The ventilation speed is set automatically in maximum mode.

3.2.8 Minimum mode operation

To select minimum mode operation



- press the key 
The symbol  on indicates that fan operation in minimum mode.

⚠ In this mode the fan is set to minimum speed.



⚠ This function can be excluded at any time by pressing the button again.

3.2.9 Set the direction of the air flow

To control the air flow direction

- press the key 
The symbol  lit on indicates the constant oscillation of the air flow deflector

To lock the airflow direction again



- press again the  key
The symbols  goes off and the air flow deflector locks in position

⚠ Never force the flow deflector manually to move it.

⚠ In cooling and heating mode, the flap position is reset every hour to prevent the formation of condensation.

3.2.10 Set the key lock

To set-up the key locking

- press both keys  for 3 seconds
The text  appearing on the display.





⚠ The remote control is also blocked and settings cannot be changed.

⚠ All settings are inhibited by the user.



⚠ Repeat the sequence to unlock the control.

3.3 Basic menu

To access the basic menu

- with the display off, hold down  for 10 seconds
The device turns on and  appears
- keep pressed until the indication  appears
- release the  key
The symbol  appears

To navigate in the menu

- use the icons  

To select a menu item and to confirm the changes made

- press the icon 
Confirming the change takes you to the next item.

To exit the menu

- press the icon  for 10 seconds
- or wait 30 seconds the automatic shutdown

⚠ After 30 seconds from the last action the control goes out and the settings is memorized.



3.3.1 Menu items

CF: Scale





ub: Buzzer volume

Fr: Factory reset

Set AIR probe offset





⚠ The set value changes by 1 °C each press of the  and  buttons.

To set the air probe regulation

- select 
- press  to change settings
- increase or decrease the value with the icons  
- press  to confirm
By default it is set to 0.
The setting range is from -9 °C (min) to +9 °C (max).





3.3.2 Scale

To change the temperature unit of measure

- select 
 - press  to change settings
 - select °C or °F
 - use the   icons to move inside the menu
 - press  to confirm
- By default the temperature unit of measure is °C.*

3.3.3 Adjusting buzzer volume

To change the volume

- select 
 - press  to change settings
 - increase or decrease the value with the icons  
 - press  to confirm
- The volume setting range is from 00 (min) to 03 (max).*

 The volume changes after confirm the modification.

3.4 Warnings

3.4.1 Operating the unit if the remote control is not available

If you lose the remote control, the batteries run out or the remote stops working, you can operate the device with the keys on the touch-screen display on-board the machine.

3.4.2 Troubleshooting



For the user it is important to distinguish any malfunction or performance levels that differ from the system's standard operating values (see technical specifications). The most common problems can be easily solved by the user by performing certain simple tasks (see the Troubleshooting paragraph), while some system alarms require that you contact the Technical Customer Service.

 Please keep in mind that any attempt by unauthorised staff to repair the device automatically voids any form of warranty.



3.4.3 Visualization of alarms on display

 In the event of a malfunction, the display shows an alarm code.



 In the event of an alarm, the device still maintains active functions.

- E1 Room temperature probe AIR/T1 disconnected or faulty
None of the modes can be activated.
- E2 Faulty internal fan motor or disconnected
None of the modes can be activated.
- E3 Water temperature probe H2/T2 disconnected or failure
None of the modes can be activated.
- CE Communication error
Errors in the communication between the touchpad control and the board. None of the modes can be activated.
The symbol  appears to indicate unsuitable radiant water.
-  lampeggiante Incorrect water temperature
In heating mode, the water temperature is below 30 °C.
-  lampeggiante Incorrect water temperature
In cooling mode, the water temperature is above 20 °C.

3.4.4 Reset filter cleaner alarm

 The flashing  symbol indicates that filter cleaning is required.

After replacement of filters, it is necessary to reset the count of hours of filter use

- press  for about 8 seconds
- The  symbol disappears.*

M7 SERIES CONTROLS EEB749 - EFB749 - EGB749

4.1 Interface

4.1.1 Description

M7 series LED electronic control panels with touch interface for wall installation allow:

- room temperature control
- management of the main functions of the device
- temperature and humidity measurement
- fan speed regulation

They are fitted with:

- internal memory with data saving even in case of shut-down or power outage

⚠ After 20 seconds after the last action the panel brightness is reduced, only the room temperature is seen on the display. The maximum brightness is restored to the pressure of any key.

4.1.2 Display

Statuses and active alarms on display.

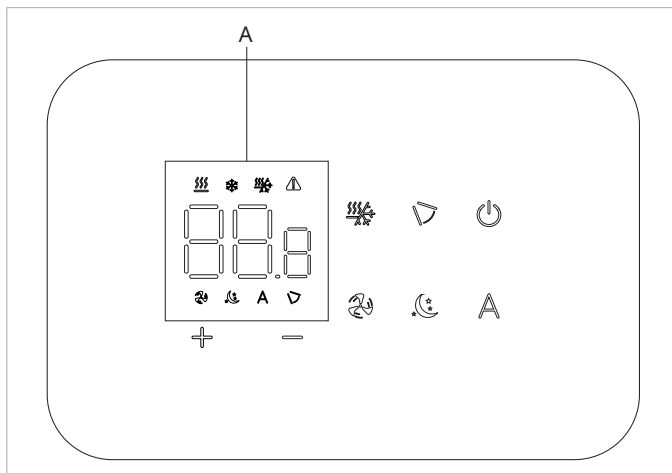

A	Display area
8888	Setpoint
+	Temperature value increase function
-	Temperature value decrease function
⏻	Power / Standby
⚠	Alarm signals
🔍	Flap control function
🌀	Maximum mode
🔥	Heating / Cooling (Cannot be used)
❄	Cooling
🔥	Heating
⏻	Auto Mode
🌀	Minimum mode

4.1.3 Keys functions

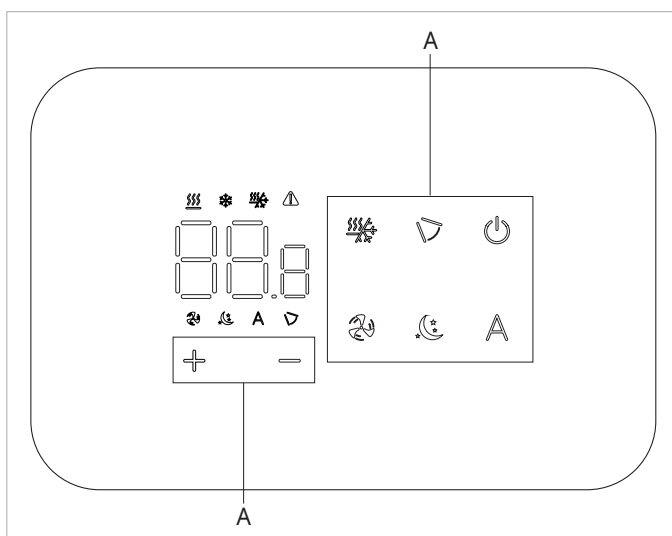

A	Keys area
+	Increases the temperature value
-	Decreases the temperature value
⏻	This can be used to switch the unit on or off
🔍	Allows flap management
🌀	Allows the maximum ventilation speed function to be activated
🔥	This can be used to select the operating mode (Cooling or Heating)
⏻	Enables automatic mode
🌀	Allows activation of the minimum mode function with ventilation speed limitation



4.2 Main functions

4.2.1 General start-up

Before the activation:



- ⚠ Make sure that the remote control is connected to the mains.
- ⚠ In case of a master switch on the power supply line, switch on the system by inserting the switch.

To activate the control

- press the  key for about 2 seconds
The text  appearing on the display.
The device turns on.

4.2.2 Put in stand-by the control



To put in stand-by the control

- press the  key for about 2 seconds
The symbol  appears
The control goes out.

- ⚠ In stand-by mode the control ensures an antifreeze safety. In case of temperature <5 °C, the hot water solenoid valve outputs and boiler consent are activated automatically.

4.2.3 Set room temperature



To set-up the temperature

- operate the   keys to decrease or increase the desired value
The displayed value change.

- ⚠ The adjustment range goes from 16 °C to 28 °C, with a resolution of 0,5 °C.
- ⚠ Out of range values from 5 °C and 40 °C are allowed, except in automatic mode. These value should be set only for short periods of time.

4.2.4 Cooling only mode



To select the Cooling operation

- press  for about 2 seconds
The lighted  symbol in the display area indicates that the Cooling function is activated.
The device dehumidifies and cools the room.

- ⚠ In cooling function the symbols is alight with setpoint lower than the room temperature.

4.2.5 Heating only mode



To select the Heating operation

- press  for about 2 seconds
The symbol  on indicates the Heating function enable.
The device heats the room.

- ⚠ In heating function the symbols is alight with setpoint higher than the room temperature.

4.2.6 Automatic operation



To select the Automatic function

- press the  key for about 2 seconds
The symbol  on indicates the Automatic function enable.

- ⚠ The ventilation speed is automatically adjusted between a minimum value and a maximum value based on an algorithm type PI, according to the actual distance from the room temperature set-point.

4.2.7 Minimum mode operation



To select minimum mode operation

- press the  key for about 2 seconds
The symbol  on indicates that fan operation in minimum mode.

- ⚠ In this mode the fan is set to minimum speed.

4.2.8 Maximum ventilation speed

To select the operation at the maximum ventilation speed



- press the  key for about 2 seconds
The symbol  on indicates the maximum speed function enable

- ⚠ Maximum power output is immediately obtained both in heating and cooling.

- ⚠ After reaching the desired room temperature, select a different function to increase the thermal and acoustic comfort.

4.2.9 Set the key lock

To set-up the key locking





- press both keys   for 3 seconds
Appears .

- ⚠ All settings are inhibited by the user.



- ⚠ Repeat the sequence to unlock the control.

4.3 Basic menu

To access the basic menu

- with the display off, hold down  for 10 second
- The device turns on and  appears
- keep pressed until the indication  appears
- release the  key
the symbol  appears

To navigate in the menu

- use the icons  

To select a menu item and to confirm the changes made

- press the icon 
Confirming the change takes you to the next item.

To exit the menu

- press the icon  for 10 seconds
- or wait 30 seconds the automatic shutdown

 After 30 seconds from the last action the control goes out and the settings is memorized.

4.3.1 Menu items

ot: AIR probe offset (air probe setting)

ur: Value read by the R.H. sensor

ut: Probe Offset PT4

uS: Humidity setpoint





ui: Humidity hysteresis

CF: Scale

ub: Buzzer volume

4.3.2 Set AIR probe offset





To set the air probe regulation

- select 
- press  to change settings
- increase or decrease the value with the icons  
- press  to confirm
*By default it is set to 0.
The setting range is from a minimum of -12.0 °C to a maximum of 12.0 °C.*

4.3.3 Set probe offset RH





 Modify only after real deviations from an actual measurement with professional instrumentation have been established.

To set the RH probe regulation

- select 
- press  to change settings
- increase or decrease the value with the icons  
- press  to confirm





4.3.4 Set the humidity setpoint

To set the humidity setpoint

- select 
- press  to change settings
- increase or decrease the value with the icons  
- press  to confirm
The setting range is from 20.0% to 90.0%.





4.3.5 Setting the humidity hysteresis

To set the humidity hysteresis

- select 
- press  to change settings
- increase or decrease the value with the icons  
- press  to confirm
The setting range is from 1 (min) to 30 (max).





4.3.6 Scale

To change the temperature unit of measure

- select 
- press  to change settings
- select °C or °F
- use the   icons to move inside the menu
- press  to confirm
By default the temperature unit of measure is °C.

4.3.7 Adjusting buzzer volume

To change the volume

- select 
- press  to change settings
- operate the   keys to decrease or increase the desired value
- press  to confirm
The volume setting range is from 00 (min) to 03 (max).

 The volume changes after confirm the modification.

4.4 Warnings

4.4.1 Long period shut-down

For seasonal shutdowns or for long periods:



- disable the device
- set the main system switch to Off

 The antifreeze function is not on.

4.4.2 In case of control blockage

 This procedure should only be carried out in the event that the control locks and no longer responds to commands.

In case of control blockage





- press both keys  and  for 10 seconds
 appears on the display accompanied by a beep.
 The control was reset.

4.4.3 Visualization of alarms on display

 In the event of an alarm, the device still maintains active functions.

 **To access the Setup menu, it is necessary to access the Basic menu. See section "Basic menu" p. 13.**

To visualise errors on the wall control panel



- access the basic menu
- press 
 Appears .
- press 
 Appears 
 press  to access the menu
 Next, the number assigned to the fancoil and the alarm code appear.

Displayed alarms



- E2 Faulty internal fan motor or disconnected
None of the modes can be activated.
- E3 Water temperature probe H2/T2 disconnected or failure
None of the modes can be activated.
- E5 H4/T3 heating water probe disconnected or faulty
None of the modes can be activated.
- E6 Incorrect water temperature with automatic season function setting
The fancoil is performing heating and cooling functions incorrectly. None of the unit's functions can be activated.
- E8 Communication error alarm
Error in the communication between the wall control panel and the fancoil. None of the unit's functions can be activated.
- h2o Incorrect water temperature
*In heating mode, the water temperature is below 30 °C
 In cooling mode, the water temperature is above 20 °C.*

 Error E8 is displayed without the error display procedure on the wall control panel.

4.4.4 Reset filter cleaner alarm

 The flashing  symbol indicates that filter cleaning is required.

After replacement of filters, it is necessary to reset the count of hours of filter use

- press  for about 8 seconds
 The  symbol disappears.

TROUBLESHOOTING

5.1 Preliminary warnings

⚠ For detailed information on accessories please refer to the "Coding accessories" p. 5 section.

Should you encounter any of the anomalies below:

- the ventilation does not start even if the water circuit is filled with hot or cold water
- the device is losing water in heating mode
- the device is losing water in cooling mode
- the device generates excessive noise
- there is dew on the front panel

Follow the instructions below:

- disconnect the device from power supply immediately
- close the water taps
- contact immediately an authorized technical support center or qualified staff

⚠ The interventions must be carried out by a qualified installer or by a specialized support center.

⊖ Do not intervene personally.

5.2 Troubleshooting table

Effect	Cause	Solution
The ventilation is delayed with respect to the new temperature or function settings.	The circuit valve requires a certain time to open and therefore to make the hot or cold water circulate inside the device.	Wait 2 or 3 minutes to allow the circuit valve to open.
The device does not activate the ventilation.	Cold or hot water is missing from the system.	Make sure the boiler or the water cooler are on.
The ventilation does not start even if the water circuit is filled with hot or cold water.	The hydraulic valve stays closed.	Demount the body of the valve and check if the water circulation is restored. Check the valve operation feeding it separately to 230 V. If you were to turn on, the problem may be in the electronic control.
	The ventilation motor is jammed or burnt.	Check the motor windings and check if the fan rotates freely.
	The wirings are not correct.	Check the electrical connections.
The device is losing water in heating mode.	Leaks at the hydraulic connections of the system.	Check the leak and tighten the connection.
	Losses in the valve group.	Check the condition of the gaskets.
There is dew on the front panel.	Detached thermal insulation.	Check the correct positioning of the thermal and acoustic insulations paying particular attention to the front one located on top of the finned coil.
There are water drops on the air vent.	High humidity conditions (>60%) might generate condensation, especially at minimum ventilation speeds.	As soon as the level of relative humidity drops, the phenomena disappears. However, a few water drops falling inside the device will not cause any malfunction.
The device is losing water in cooling mode.	The condensate tray is clogged.	Slowly pour a bottle of water in the lower section of the battery to check the drainage; if necessary clean the tray and/or improve the slope of the drain pipe.
	The condensate discharge pipe does not have the slope required for correct drainage.	
	The connection pipes and the valves unit are not well insulated.	Check the pipe insulation.
The device generates excessive noise.	The fan touches the structure.	Verify
	The fan is unbalanced.	The unbalancing generates excessive machine vibrations: replace the fan.
	Check the filters for dirt and clean them if necessary	Clean filters

MAINTENANCE

Routine maintenance is essential to keep the device always efficient, safe and reliable over time.

6.1 Preliminary warnings

Before each cleaning and maintenance intervention:

- disconnect the device from the power mains by turning the system master switch to "OFF"
- wait for the components to cool down in order to avoid any burns

⊖ Carrying out any technical or cleaning work before disconnecting the unit from the power supply is forbidden.

⚠ Make sure that there is no voltage before operating.

⚠ After completing the maintenance work, must be restored the original condition.

⚠ Warnings:

- Do not lean or sit on the fancoil to avoid damaging the appliance.
- Do not manually move the horizontal louver of the air outlet. Always use the remote control to do this operation.
- If water leaks from the device, you must switch it off immediately and disconnect the power supply. Then, call the nearest customer service centre.
- The device must not be installed in rooms where there are explosive gases or where there are conditions of humidity and temperature out of the limits defined in the installation manual.
- Clean the filter regularly.

6.2 Routine maintenance

⚠ Routine maintenance is essential to keep the device always efficient, safe and reliable over time.

Carry out cleaning:

- every six months

Before each cleaning and maintenance intervention:

- disconnect the device from the power mains by turning the system master switch to "OFF"

⚠ Wait for the components to cool down in order to avoid any burns.

⚠ After completing the maintenance work, must be restored the original condition.

⊖ It is forbidden to open the access doors and carry out any technical or cleaning intervention, before having disconnect the device from the mains supply by placing the main switch of the system on "OFF".

6.2.1 External cleaning

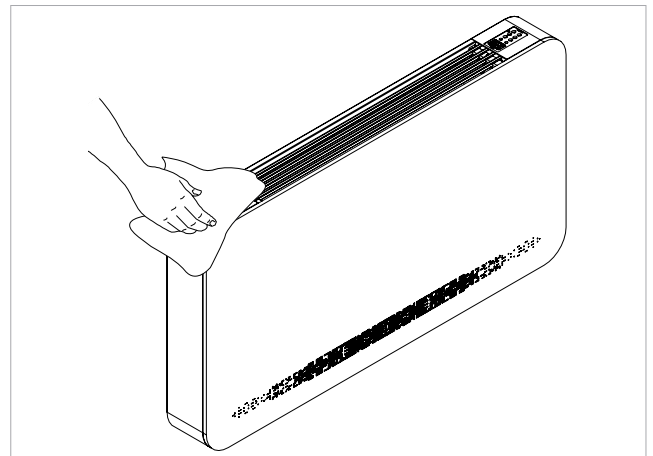

Clean the external surfaces using a soft cloth dampened with water.

⚠ Do not use abrasive sponges or abrasive or corrosive detergents as you might damage the painted surface.

⚠ Disconnect the unit from the power supply before each cleaning and maintenance intervention by setting the main power supply switch to off.

6.3 Air intake filter cleaning

Cleaning the filter must be carried out:

- after prolonged operation, considered the concentration of impurities in the air

- when you plan to restart the system after prolonged disuse

- 1. Cover cabinet
- 2. Air intake filter

- 3. Plastic tabs

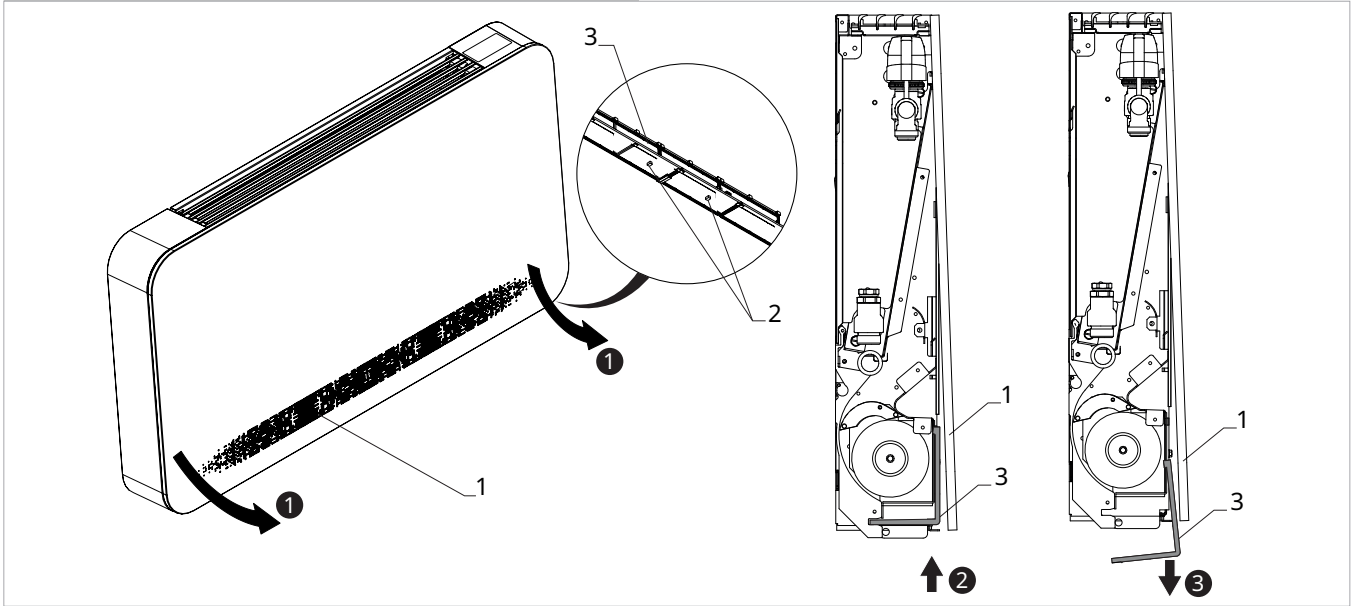

To remove the filter:

- Distance the bottom of the cover cabinet by pulling it toward you
- Push up the plastic tabs on the bottom of the filter
- Unhook the filter from its housing
- remove the filter by pulling it downwards

To reassemble the filter:

- proceed in reverse order

⚠ Check that the filter is fitted correctly.

⊘ It is forbidden to use the device without its mesh filter.

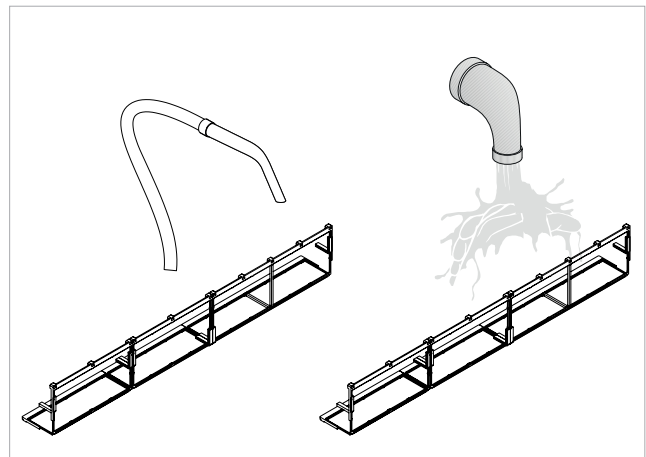

To clean the filters:

- use a vacuum cleaner
- aspirate dust
- wash the filter with running water
- allow it dry

6.4 Suggestions for energy saving

For a correct operation of the device and a great energy saving:

- keep the filters clean
- keep the doors and windows of the locations fitted with air conditioning systems closed as much as possible
- During summer limit the entry of direct sun rays into the rooms to be air-conditioned by means of external screens (projections, curtains, shutters, etc.)



innova

INNOVA S.r.l.
Via I Maggio 8 - 38089 Storo (TN) - ITALY
tel. +39.0465.670104 - fax +39.0465.674965
info@innovaenergie.com